

# Acoustic Sensor Networks for Decommissioning

T.A. York,  
P.N. Green,  
P.R. Green,  
A. Phasouliotis,  
Z. Qu and  
S. Watson

School of Electrical & Electronic Engineering  
University of Manchester, M13 9PL UK

M. Hussain,  
S. Nawaz and  
N. Trigoni

Department of Computer Science  
University of Oxford, OX1 3QD UK

S. Stanley  
National Nuclear Laboratory  
Sellafield, CA20 1PG UK

Professor T.A. York  
(corresponding author)

t.a.york@manchester.ac.uk

## Abstract

Progress is reported with an acoustic sensor network that offers the possibility to provide monitoring of nuclear storage ponds. The aim is to create a network that comprises a number of autonomous sensor nodes that communicate and localise using ultrasonic signals. The nodes are less than 20cm dimension and are able to manoeuvre themselves, horizontally and vertically, to selected positions where they can then record measurements of selected parameters. Ultrasonic signal propagation has been explored in a 6m benign test pond with representative clutter. The paper describes progress with communications, localisation and a small autonomous underwater vehicle. Results suggest that localisation might be achieved to an accuracy of about 10cm and data might be communicated up to 1 kbit/s assuming a bit error rate of 10<sup>-4</sup>.

## 1. Introduction

The global challenge to manage the safe storage of nuclear waste is well documented and acknowledged. Much of the present waste is stored in ponds and, as some of these are more than 60 years old, there is an urgent need for safe, efficient, decommissioning in order to relocate the contained waste. A significant challenge is to understand the conditions in the ponds. The waste is contained beneath several metres of water in ponds that may be the size of an Olympic swimming pool. Over the years the material has, naturally, corroded and the condition of the resulting sludge must be determined prior to implementing a removal strategy. So, for instance, is the sludge hard or soft? Does it need to be broken up first or can it be pumped away? A number of potential solutions present themselves as candidate technologies to provide the necessary monitoring. Perhaps the most obvious suggestion might be to utilise a "dipstick" approach. Using gantries over the ponds dipsticks could be manoeuvred to map the conditions. However, this approach is accompanied by significant risk. Existing gantries are, necessarily, large to manage the manipulation of the contents of the pond, and any movement introduces the possibility of damaging the pond. New, smaller gantries might be suggested but, typically, such construction is prohibited to avoid further risk of damage to the pond. Another "obvious" solution might be to use existing underwater vehicles that are commonly used in marine activities, typically associated with

the oil industry. Such vehicles are typically remotely operated (ROV) at the end of an umbilical tether which can present problems when exploring the cluttered regions at the bottom of the ponds, which is, naturally, of most interest. Although such vehicles are now being used for such purposes they are not ideal. Typically they are expensive and the largest dimension may be a metre or more. In addition, mapping a pond with a single dipstick or ROV is both prohibitively time consuming and mitigates against on-line, continuous monitoring.

We are exploring possibilities for realising wireless sensor networks to monitor industrial processes [1]. In contrast to almost all other wireless sensor networks this work is characterised and challenged by the propagation of signals in confined spaces through materials that are not predominantly air. Initial work focussed on non-conducting media in which electromagnetic signals can propagate effectively. The target demonstrator considered the monitoring of grain silos in which, for instance, it is desirable to identify when conditions are conducive to the production of dangerous toxins. A demonstrator comprising 10 networked nodes using microwave signals at 868 MHz has been realised. A subsequent project is considering the possibilities for networks in conductive media, particular aqueous environments, which predominate in industrial processes. Electromagnetic signals are seriously attenuated in such media and the most obvious solution is to consider acoustic signals. High frequency signals are desirable in order to achieve high temporal, and as a result spatial, resolution. However, attenuation increases with frequency and therefore a compromise must be identified. The present work targets frequencies from

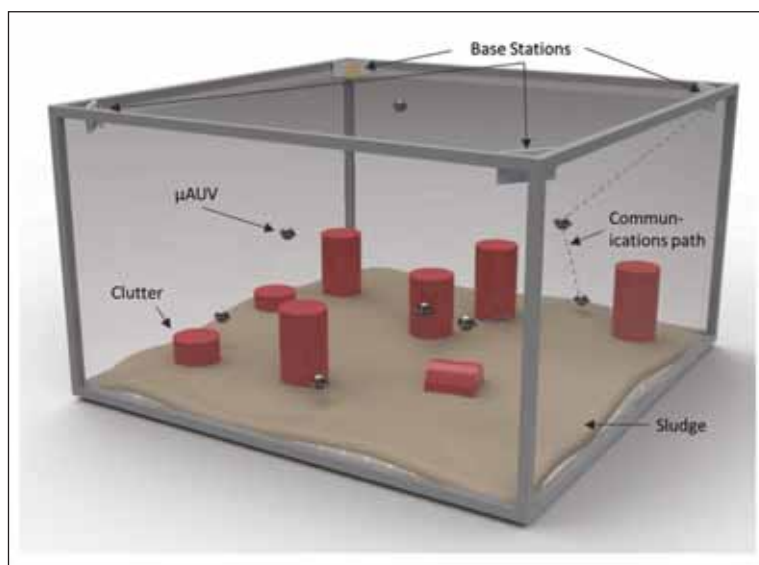

Figure 1: Schematic of the sensor network in a storage pond

40-200 kHz. Much related work has been undertaken in the open-water, marine, environment but the significant difference is that in the present case, due to the confined and cluttered nature of the region of interest, the signals are subject to many reflections resulting in a considerable multipath challenge. The present paper considers the possible application of this generic technology to the monitoring of nuclear storage ponds.

A schematic representation of the proposed wireless sensor network is shown in Figure 1. The autonomous sensor nodes roam around the region and are able to detect

ultrasonic signals from base stations at the edge of the pond. The time of arrival of such signals can be used to identify the location of the nodes and, although this is relatively straightforward in the open water, it becomes extremely challenging when there is no direct line of sight. Part of the present work is exploring how to accommodate such situations. The nodes can also transmit signals but, due to power limitations this can only be over relatively short distances. Data are communicated from the sensor nodes to the base stations and then the host system via a series of hops between neighbouring nodes. The challenge of reliably transmitting data in the presence of the highly reflective multipath is informed substantially from the modulation techniques that are used so effectively in the relatively mature field of RF communications and forms a substantial part of the research as outlined in Section 2. The ability to communicate effectively provides the opportunity to navigate and explore the environment and progress to date is described in Section 3.

All of the issues outlined above assume that a suitable autonomous underwater vehicle (AUV) is available. In any industrial application it is almost statutory that the sensor nodes have little or no effect on the process and it is, inevitably, desirable, that they are

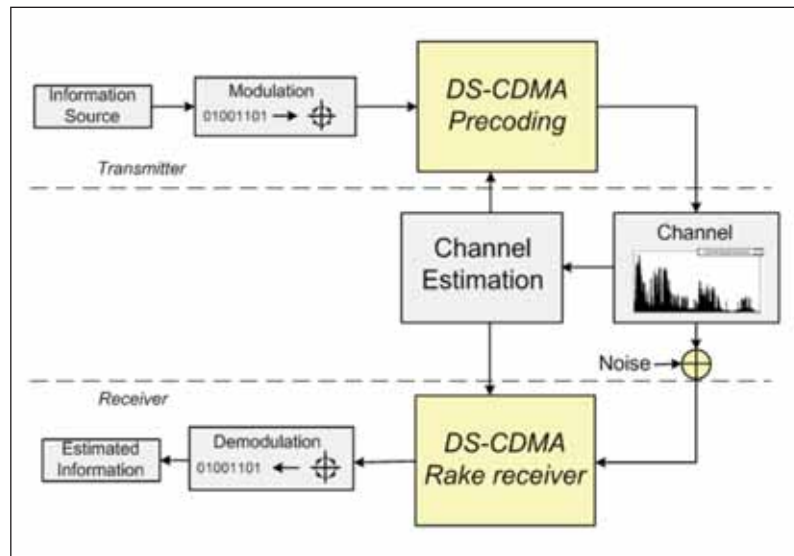

Figure 2: CDMA based communication system

inexpensive. This mitigates against the commercially available offerings. The challenge for the present work is to implement low-cost micro-vehicles ( $\mu$ AUV), of about 10cm dimension, and progress is reported in Section 4. This paper gives an overview of the challenges and progress to date and the reader is directed to more detailed expositions where appropriate.

## 2. Communications and Ranging

In this work the communication between  $\mu$ AUVs and base stations takes place in a confined underwater environment, for instance nuclear waste storage ponds. The basic requirements include base station-to-node communications, for instance to send instructions to the nodes, node-to-base station communications, to transfer data out of the pond, and node-to-node communication to assist with the data transfer in cases where there is no-line-of-sight (NLOS) path between transmitting node and base station. Node-to-node is also used to support swarm-based mapping behaviour. The main data rate targets of 1 Kb/s and 200 Kb/s can support transmission of sensed data and low frame rate video respectively.

In such environments multiple reflective surfaces exist, such as the walls and surface of the ponds and the

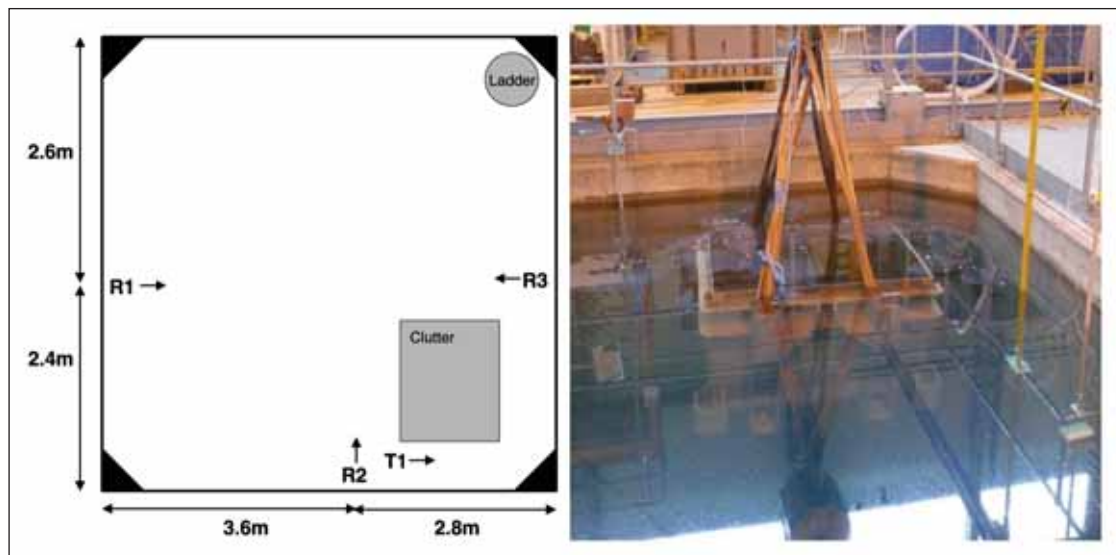

Figure 3: Test Environment with Clutter

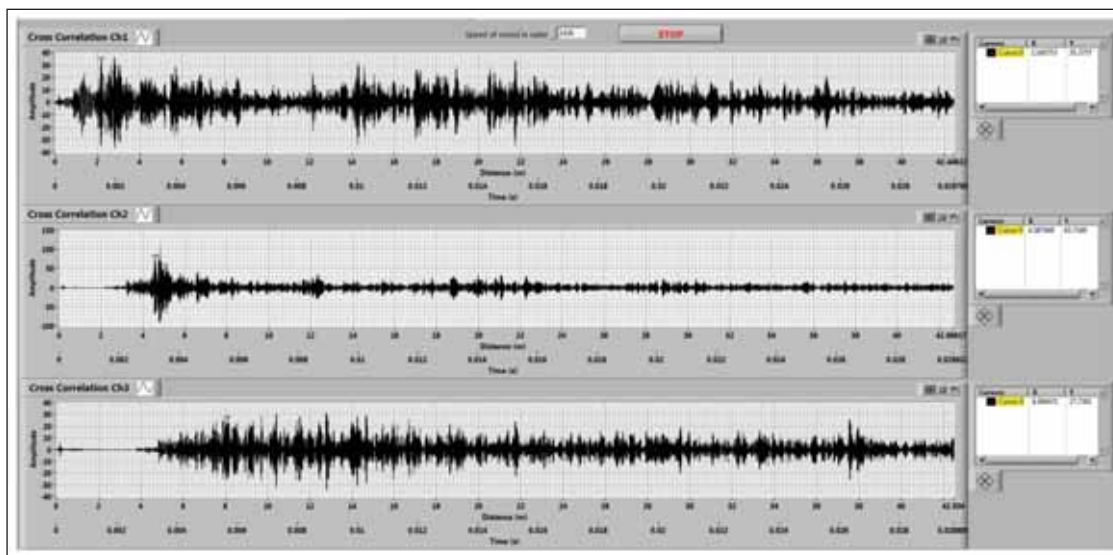

Figure 4: Cross-correlation results

clutter, and this means that the geometry of such a communication scenario imposes rich multiple signal echoes, referred to as multipath. Furthermore, the existence of obstructions inside the ponds hinders line-of-sight (LOS) transmission and NLOS transmissions are produced which lead to even more signal reflections. The resulting channel is highly frequency selective and it may cause many data to overlap, referred to as inter-symbol interference (ISI).

The strong multipath propagation and the multiple access interference (MAI), arising from multi-link transmissions in the underwater wireless sensor network, strongly distinguishes the channel profile under investigation, compared to the long-range, relatively “un-cluttered”, open-sea communication channel [2]. Hence careful selection of the communication system design is required. To provide low transmission power and robustness against multipath, the spread spectrum (SS) code division multiple access (CDMA) based system shown in Figure 2 has been chosen as the communication system [3]. At the transmitter, pre-coding techniques are used as a method of limiting interference and achieving reliable multi-access communication within the densely deployed wireless sensor network. A receiver technique known as rake [4] combines the signal energy from a number of received multipath components and mitigates the ISI.

Figure 3 shows one of the many channel measurement experiments, undertaken at the National Nuclear Laboratory (NNL), which illustrates the challenges of underwater communications in enclosed storage ponds under cluttered conditions. In this experiment a Neptune Sonar T204 transducer (T1) transmits signals that are received by three transducers (R1, R2, R3) on the walls of the pond. The arrows indicate the direction of the transducers which are all at a depth of 1m. The signals are reflected from the walls of the pond, the clutter and the surface of the water. The clutter is a metal cube measuring approximately 1.5m in dimension. A maximum length pseudo-random sequence (MLS) of length 63 chips is binary phase shift key (BPSK) modulated and applied to a carrier signal of frequency 40 kHz before transmission. The pseudo random sequence is used to encode the acoustic signal before transmission in order to help the signal detection process at the receiver. The amplitude of the transmitted

signal is 20 Volt peak-to-peak.

Figure 4 depicts the cross-correlation between the transmitted and the received signal detected at the three receiving points. The vertical axis shows the amplitude of the signal and the horizontal axis shows time. These results can be used to estimate the channel impulse response (CIR) for each transmission and also to provide an idea of how the received signal is distorted when passing through the underwater channel. Figure 4 illustrates the challenge of communicating in such an environment. Clearly the middle trace, representing the path with best visibility, has the cleanest signal from which it could be expected that the range might be readily determined. The other two traces display significantly more structure, arising from the increased multipath. It is notable and significant that the first arrival is not necessarily the strongest, a situation that is common in such environments. The range can be determined from the time of flight.

Current efforts are focussed on transmitting measured data and determining the bit-error rate (BER) performance of the communication system.

### 3. Localisation

As a  $\mu$ AUV moves inside the storage pond it must be able to determine its location inside the pond. This is essential in order to determine spatial distributions of sensed parameters and to enable exploration. Typically, localisation involves measuring distances to fixed references with known coordinates and then using multilateration to determine the unknown coordinates. We have developed two different localisation approaches that address the challenges that arise due to multipath and non line-of-sight signal propagation.

#### One-Hop Localisation

The first approach focuses on the scenario where  $\mu$ AUVs estimate direct distances to fixed references attached to the pond infrastructure. The ultrasound pulses used to measure time of flight (ToF) between the references and a  $\mu$ AUV can suffer from severe multi-path depending on the surrounding clutter. Therefore, in this scenario, a  $\mu$ AUV can receive a number of legitimate signals which suggest a choice of distance measurements to fixed reference nodes. It is not known which of these measurements have large errors due to Non-Line-of-Sight (NLOS) signal propagation.

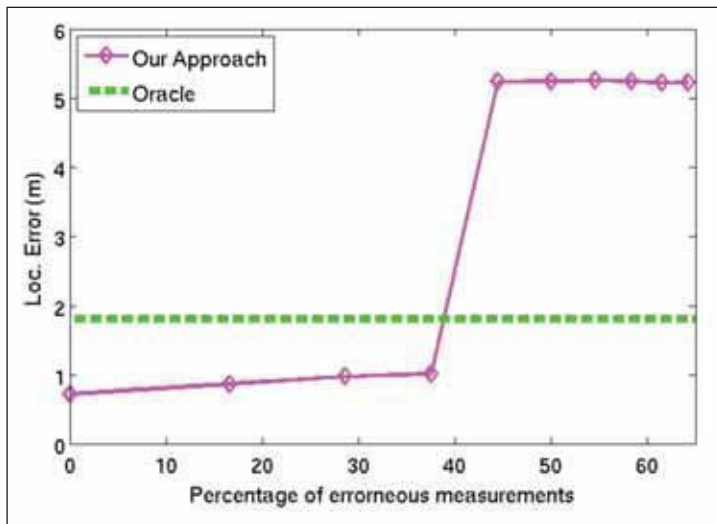

Figure 5: Comparison of One-Hop Localisation with Oracle

The current body of research generally addresses this problem by identifying the Line-of-Sight (LOS) and Non-Line-of-Sight (NLOS) range measurements [5,6,7]. The erroneous measurements are then either removed completely or assigned smaller weights while calculating the coordinates of the unlocalised node. The identification of LOS and NLOS measurements generally relies on the characteristics of the received signals at the physical layer [8]. Therefore, it is specific to the modality used to perform ranging and cannot be used across different physical layers. Current research in NLOS identification has exclusively focused on radio technologies and is thus not directly applicable to underwater ultrasound ranging.

The present approach to localising in cluttered NLOS environments is to employ error correction. The resulting localisation algorithm [9] determines which distance measurements are erroneous and the errors in such measurements by solving a convex optimization problem. The estimated errors in the range measurements are removed and the coordinates of the unlocalised node are then calculated using multilateration. Theoretically the proposed algorithm is robust when up to 50% of the distance measurements contain large positive errors. In order to empirically verify the robustness of the algorithm experiments have been conducted using Jennic sensor nodes in a 15m x 10m room. These sensor nodes perform range measurements by measuring the round trip time (RTT) of radio packets. Two sensor nodes were used to record the range measurements at various positions. Measurements were compared against those obtained using a laser range finder. Five LOS measurements were used and the number of erroneous NLOS measurements was gradually increased from 0 to 9. In this way the total number of measurements varied from 5 to 14 with the percentage of erroneous measurements varying from 0% to 65%. An Oracle algorithm, that has complete knowledge regarding which measurements are erroneous and can therefore be ignored, was used for comparison. Representative

results are shown in *Figure 5* which suggests that in this setting the algorithm is robust even in the presence of 40% erroneous measurements.

### Multi-Hop Localisation

The second approach relies on special purpose nodes, referred to as localisers, to assist in localisation of the autonomous vehicles. Localisers are manoeuvred to appropriate locations to enable them to relay the signals between the  $\mu$ AUVs and the base stations. This allows the unlocalised sensor nodes to estimate multi-hop distances to the base stations. Results suggest that the localization accuracy can be improved significantly by judicious positioning of the localisers [10]. This is completely different from

existing NLOS detection and mitigation techniques that rely on the assumption that only a small percentage of the range measurements are affected by NLOS propagation [11,5,12]. The present algorithm determines the optimal positions of the localisers to minimise the localisation error given the layout of the clutter inside the pond. The proposed algorithm works by dividing the available area into a grid. Each grid point represents a possible location for a localiser and is connected to other grid points or reference nodes that are within the communication range. If the edge does not cross an obstacle it is assigned a weight that is equal to the Euclidean distance between the points that are connected by this edge. However, if it crosses an obstacle, it is assigned a higher weight. An algorithm is then used to find the shortest path in this graph between each reference node and  $\mu$ AUV. The grid points that form these shortest paths are the locations where localisers must be positioned. *Figure 6* shows a cluttered environment, represented by rectangles. Triangles at the edge are base stations and those elsewhere are localisers that are manoeuvred to positions that are determined by the algorithm. These facilitate multi-hop communication, in a difficult situation, between the  $\mu$ AUV, shown as a small circle, and the base stations.

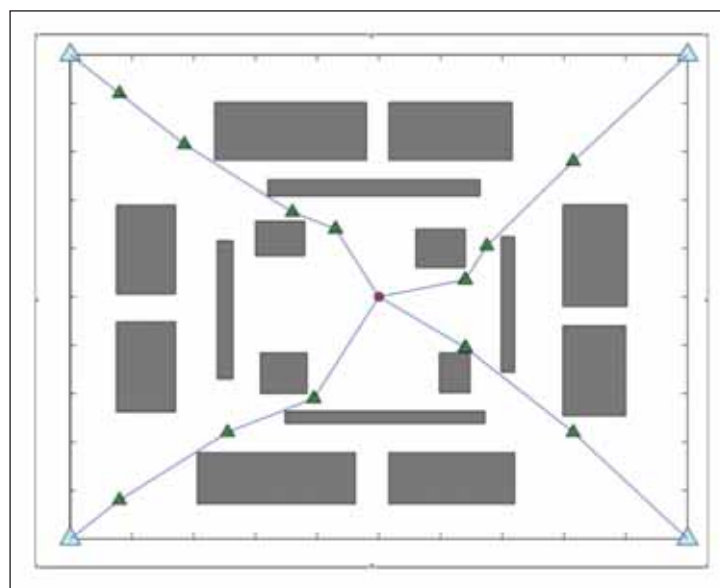

Figure 6: Optimal placement of localisers

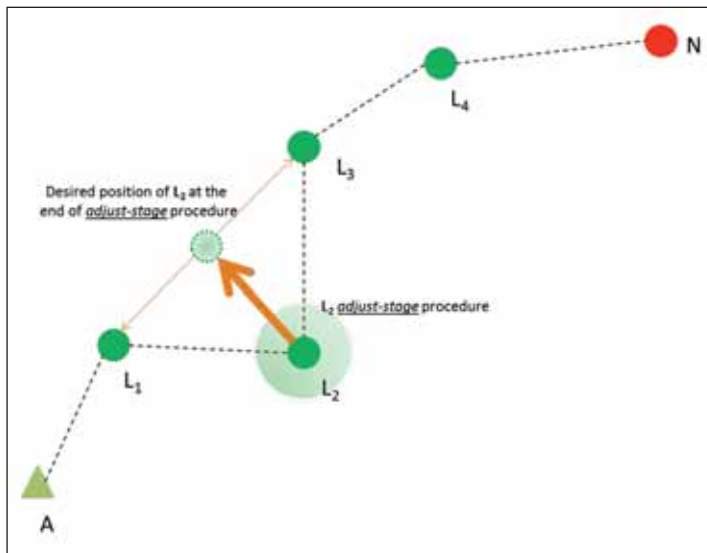

Figure 7: Dynamic localiser adjustment to minimise localisation error

A practical approach has also been developed where the localisers adjust their positions inside the cluttered environment if they are deployed in a random manner [13]. The aim of this algorithm is to move the localisers in each of the multi-hop chains such that their final positions minimize the multi-hop distance between the base station and the sensor  $\mu$ AUV. The key component of the algorithm is the “adjust stage” during which a localiser moves such that it aligns itself with its two adjacent neighbours, which can be other localisers, base stations or a  $\mu$ AUV. This is shown in Figure 7 where a localiser labelled as L2 is moving to align itself with L1 and L3.

#### 4. Micro Autonomous Underwater Vehicle ( $\mu$ AUV)

The  $\mu$ AUV has been designed around a set of requirements which takes into account the needs of both the generic technology and the specific application to monitor nuclear storage ponds. The mechatronic development includes the design of the hull, propulsion systems, low-level motion control and power system.

The vehicle should :

- Have the ability to move to any 3D coordinate in a controlled manner
- Provide at least 4 degrees of freedom to allow investigation of cluttered environments
- Decouple vertical and horizontal movement
- Work at depths of up to 15m
- Run off an independent, re-chargeable power supply
- Be an order of magnitude smaller than the clutter, but able to house all the components

The state of current underwater exploration vehicle technology, autonomous underwater vehicles (AUVs) and remotely operated vehicles (ROVs), prohibits the use of an off-the-shelf- vehicle due to size, manoeuvrability, power consumption and, in the case of ROVs, the umbilical cable.

The design of the prototype vehicle is based on a parametric analysis of the system and a comprehensive study of hull shapes and propulsion systems [14, 15]. The vehicle which has been developed is spherical, with a diameter of 150mm. A schematic representation of the anticipated “production” unit is shown in Figure 8. Six thruster units, driven by DC motors with propellers, are mounted around the equator of the vehicle and provide surge, sway, heave and yaw

[16]. The control systems for the low-level motor control are hosted by a dual-processor PCB which allows independent control of all six thruster units. Control is informed by inputs from a pressure sensor for depth and a digital compass and rate gyroscope for angular velocity and position.

The requirement to use low-cost, off-the-shelf components, particularly the thruster units, presents challenges for the control systems. Imbalanced and time-varying thruster forces, low construction tolerances and measurement errors cause a number of unwanted side-effects, which place increased demands on the quality of the control systems.

Figure 9 shows the results of an open-loop test when a pair of thrusters were both turned on [17]. In an ideal scenario, the thrust outputs should be

the same and the vehicle should move in a straight line with no change in angular position. The graph, showing angular position of the  $\mu$ AUV against time, shows that the vehicle rotates at a varying rate. Control systems to combat these effects are being developed individually before being combined to allow for full 3D controlled movement. To date, control systems for vertical motion and limited horizontal motion (yaw and open-loop surge) have been designed and successfully tested [17, 18].

The vertical controller is a PID $\gamma$  system. Figure 10 shows the results from a staircase input where the vehicle is tasked with moving to 3 depths and to hold station at each one. The “staircase” represents the desired behaviour. The other three lines show simulated results, assuming constant and variable mass respectively, and the actual measured behaviour. The actual measurements closely track the simulation with variable mass. A steady-state error is evident at each station. This is caused by the vehicle being positively buoyant.

A PI controller has been developed for yaw and open-loop surge control, however the results to date are mixed. Further work in progress is developing a more advanced control system which is being integrated with



Figure 8: Schematic of the  $\mu$ AUV

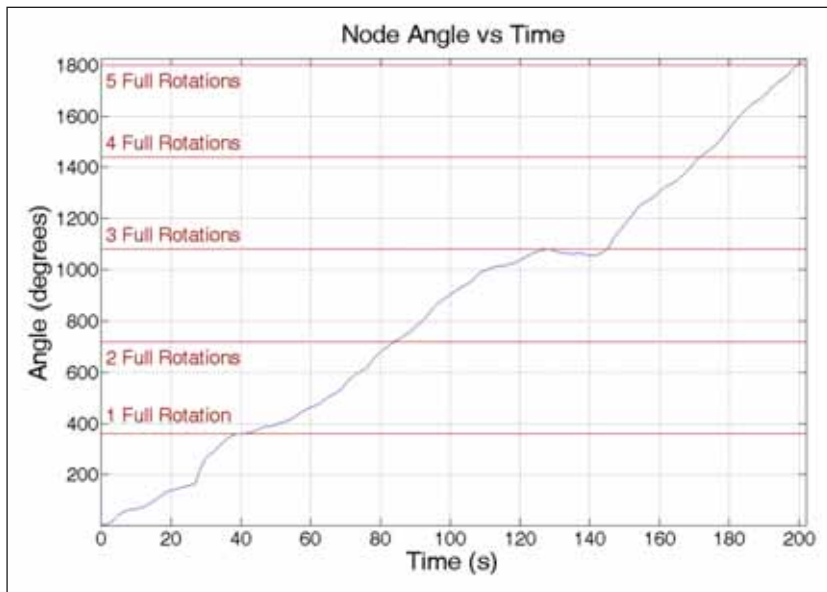

Figure 9: Open-Loop Test Measurements

the vertical system to allow for two-plane movement. Future work will entail the integration of other hardware such as the acoustic communications and positioning system, obstacle detection system and the embedded system. This will allow the development of a full 3D control system and subsequent integration of the higher level navigation and exploration algorithms.

## 5. Summary

The paper has presented progress towards the realisation of acoustic sensor networks for industrial processes. Target applications are characterised by the challenges due to reflections in the confined, cluttered, space and involve propagation of signals in media other than air. The paper focuses on the potential to exploit this technology for monitoring nuclear storage ponds. An overview of progress with communications, ranging, localisation and manoeuvrability of the sensor nodes is presented.

It is likely that it is not possible to remove the sensor nodes from the ponds. In this case it is necessary to consider how to recharge the batteries. Work is in progress to explore possibilities for the nodes to navigate to inductive recharging stations.

One issue that must be considered is the radiation tolerance of the sensor nodes. Typical integrated circuits might be able to withstand 500-1000 Rads [19]. Radiation tolerant electronics, for instance Honeywell offer radiation hardened technology that reportedly can withstand a total ionising dose of greater than 1 Mrad. However, such technology is typically several generations behind in terms of performance and is unlikely to be able to deliver the required functionality in a reasonable timescale. As an indication of the activity that

is likely to be encountered, information authored by D. Majersky of Alldeco, "Removal and solidification of the high contaminated sludges into the aluminosilicate matrix sial during decommissioning activities", and available on the International Atomic Energy Agency website describes decommissioning work in the Slovak Republic in which dose rates of 5 to 100 Rad per hour were measured at the bottom of the pond. From the above this continuous level of exposure might equate to 5 to 200 hours of operation of conventional integrated circuits or more than 104

hours, just over 1 year, with radiation hard integrated circuits. It should, of course, be acknowledged that the  $\mu$ AUVs will only spend a small proportion of their time at the bottom of the pond and therefore the anticipated averaged dose rate might be significantly less than that suggested above. One possibility for the  $\mu$ AUVs is that it might be possible to utilise the ballast as protection. The present prototypes have about 1 kg of lead in the bottom to provide the correct buoyancy and larger nodes would allow more lead to be included. Alternatively, it is possible to envisage a design that has the sensor heads suspended some distance below the electronics.

The paper has suggested opportunities for monitoring the condition of storage ponds in preparation for decommissioning. Other scenarios present themselves, for instance the sensor networks offer the possibility to monitor active ponds, possibly to maintain a map of temperature. Also, eventually, during decommissioning duties it is envisaged that the sensor nodes might be manoeuvred to appropriate locations in order to provide early identification of changes to the environment, for instance rise in temperature or release of radiation.

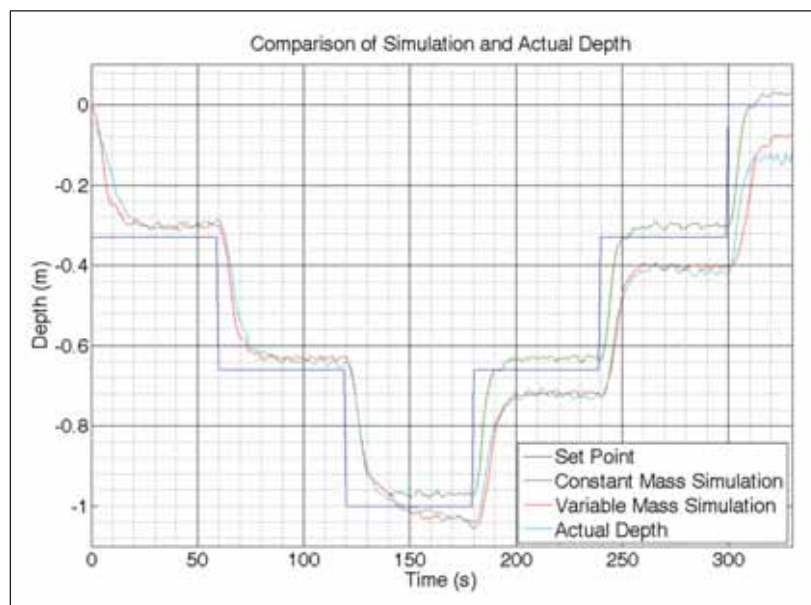

Figure 10: Closed-Loop Vertical Controller Test Results

## 6. Acknowledgements

The authors would like to acknowledge the support of the UK Engineering & Physical Sciences Research Council in providing two grants under the WINES initiative (EP/D076900, EP/F064578). Also, to the collaborative support of the National Nuclear Laboratory, Yorkshire Water and Phoenix Inspection Systems.

## 7. References

- [1] G. Parkinson, D. Crutchley, P.M. Green, M. Antoniou, M. Boon, P.N. Green, P.R. Green, R. Sloan and T. York, Environmental Monitoring in Grain, 'Proc. IEEE Instrumentation and Measurement Technology Conference', Austin, USA, 2010, 939-943.
- [2] M. Stojanovic, Recent Advances in High-Speed Underwater Acoustic Communications, 'IEEE J. Oceanic Eng.', 1996, 21, 2, 125-36.
- [3] J. Fischer, K. Bennett, S. Reible, J. Cafarella and I. Yao, A high rate, underwater acoustic data communications transceiver, 'Proc. OCEANS'92', Newport, RI, USA, 1992, 571-576.
- [4] A. Singer, J. Nelson and S. Kozat, Signal Processing for Underwater Acoustic Communications, 'IEEE Comms. Mag.', 2009, 47, 1, 90-96.
- [5] L. Cong and W. Zhuang, Non line-of-sight error mitigation in mobile location. 'IEEE Transactions on Wireless Communications', 2005, 4, 560-573.
- [6] I. Guven, C-C Chong, F. Watanabe and H Inamura, NLOS identification and weighted least-squares localization for UWB systems using multipath channel statistics, 'EURASIP J. Adv. Signal Process', 2008, 36.
- [7] S. Venkatesh and R.M. Buehrer. A linear programming approach to NLOS error mitigation in sensor networks. 'Proceedings of the 5th international conference on Information processing in sensor networks', 2006, 301-308.
- [8] S. Venkatesh, and R.M. Buehrer, Non-line-of-sight identification in ultra-wideband systems based on received signal statistics, 'IET Microwaves, Antennas & Propagation', 2007, 1, 6, 1120-1130.
- [9] S. Nawaz and N. Trigoni, Convex programming based robust localization in NLOS prone cluttered environments, '10th International Conference on Information Processing in Sensor Networks (IPSN)', 2011, 318 -329.
- [10] M. Hussain and N. Trigoni, Distributed localization in cluttered underwater environments, 'Proceedings of the Fifth ACM International Workshop on UnderWater Networks', 2010, 8:1-8:8.
- [11] P. Chen, A non-line-of-sight error mitigation algorithm in location estimation. 'IEEE Wireless Communications and Networking Conference', WCNC, 1999, 316-320.
- [12] J. Khodjaev, Y. Park and A. Saeed Malik, Survey of NLOS identification and error mitigation problems in UWB-based positioning algorithms for dense environments, 'Annals of Telecommunications', 2010, 65, 5, 301-311.
- [13] M. Hussain and N. Trigoni, Dynamic node placement for multi-hop localization in cluttered environments, '8th Annual IEEE Communications Society Conference on Sensor, Mesh and Ad Hoc Communications and Networks (SECON)', 2011.
- [14] S. Watson and P.N. Green, A De-Coupled Vertical Controller for Micro-Autonomous Underwater Vehicles, 'IEEE International Conference on Mechatronics and Automation', Beijing, 2011.
- [15] S. Watson, and P.N. Green, Propulsion Systems for Micro-Autonomous Underwater Vehicles ( $\mu$ AUVs), 'Proc, 4th IEEE Conf. on Robotics, Automation and Mechatronics', Singapore, 2010, 435-440.
- [16] T.I. Fossen, Guidance and Control of Ocean Vehicles, John Wiley & Sons, 1994.
- [17] S. Watson, D.J.P. Crutchley and P.N. Green, . The Design and Technical Challenges of a Micro-Autonomous Underwater Vehicle ( $\mu$ AUV), 'IEEE International Conference on Mechatronics and Automation', Beijing, 2011.
- [18] S. Watson, and P.N. Green, Design Considerations for Micro-Autonomous Underwater Vehicles ( $\mu$ AUVs), 'Proc, 4th IEEE Conf. on Robotics, Automation and Mechatronics', Singapore, 2011b, 429-434.
- [19] D. Fleetwood, Radiation Hardening 101: How To Protect Nuclear Reactor Electronics, 'IEEE Spectrum', March 22, 2011.